

Table of Contents

Rogan Series —

30,000 psi Maximum Working Pressure

HP006 Coupler D3
 HP006 Nipple (without Check Valve) D4
 HP006 Nipple (with Check Valve) D5
 HP010 Coupler D6
 HP010 Nipple (without Check Valve) D7
 HP010 Nipple (with Check Valve) D8

C Series Hydraulic Couplers —

29,800 psi Maximum Working Pressure

115 Coupler D10
 115 Nipple D11
 116 Coupler D12
 116 Nipple D13
 125 Coupler D13
 125 Nipple D14
 Adapters D15

WB Series Waterblast Couplers —

10,000 psi Maximum Working Pressure

WB Coupler D17
 WB Nipple D17



Rogan Series

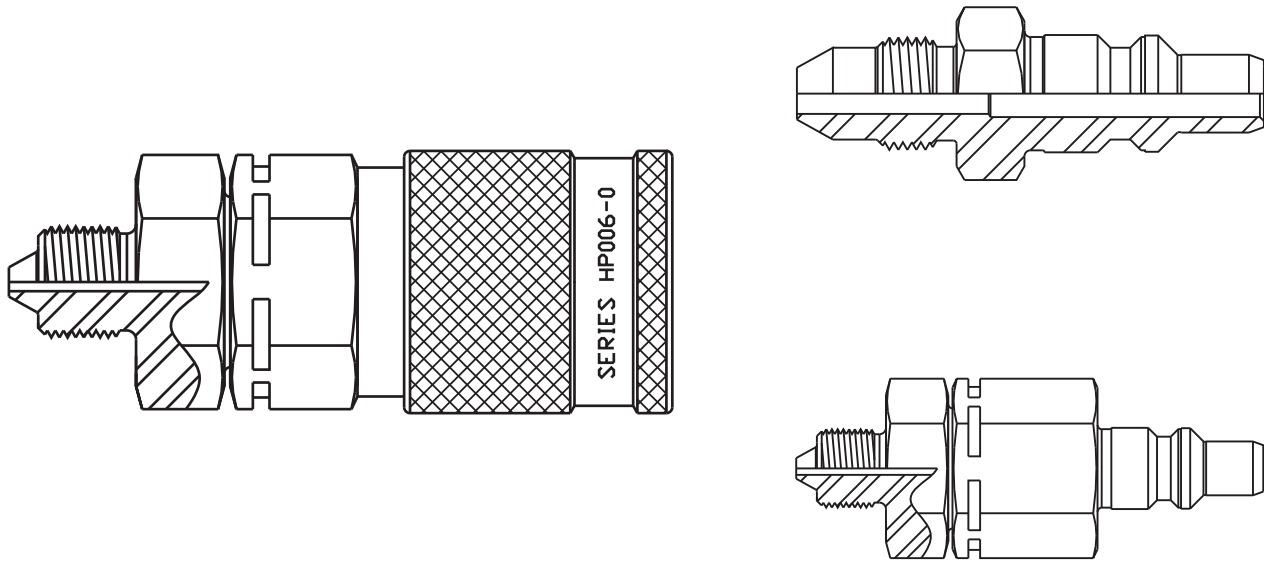



A versatile connecting device that permits easy and rapid joining of hose assemblies to your system. Each coupling is assembled and pressure tested to at least 5,000 psi above its maximum rated working pressure. Couplings with check-valve can withstand the full working pressure in the disconnected condition.

Type	Max. Working Pressure (psi)	Test Pressure (psi)	Nominal Thru Hole Diameter (in)
HP006	30,000	35,000	0.24
HP010	20,000	25,000	0.40

NOTE: The choice of the threaded end form may limit the working pressure and the size of the thru hole in the coupling. Call **polyflex™** for additional information.

HP006

Coupler

Part Number	Connection Type	A Overall Length	H Hex Size	Maximum Working Pressure
#				
		inch	inch	psi
HP006-0-A9	Type "M" (9/16" - 18 threads)	3.30	1.19	30,000
HP006-0-A12	Type "M" (3/4" - 16 threads)	3.34	1.19	30,000
HP006-0-HM4	1/4" High Pressure Male	3.46	1.19	30,000
HP006-0-HM9	9/16" High Pressure Male	3.70	1.19	30,000
HP006-0-LM6	3/8" Medium Pressure Male	3.54	1.19	20,000
HP006-0-NFB	1/4" NPT Female	3.30	1.19	15,000
HP006-0-NFC	3/8" NPT Female	3.30	1.19	15,000
HP006-0-NMB	1/4" NPT Male	3.40	1.19	15,000
HP006-0-NMC	3/8" NPT Male	3.30	1.19	15,000
HP006-0-NMD	1/2" NPT Male	3.45	1.19	15,000
HP006-0-X13	Low Angle Face Seal (9/16" - 18 threads)	3.37	1.19	30,000

D

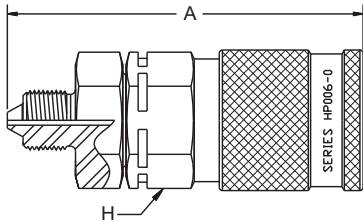

HP006-0-HM4

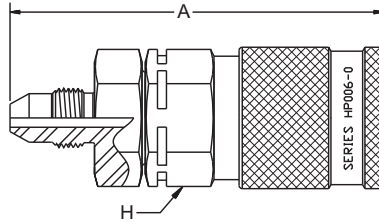

HP006-0-LM6

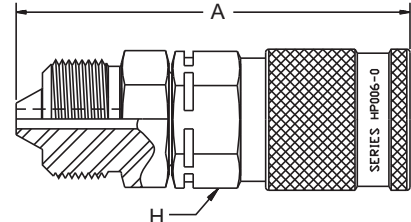

HP006-0-HM9

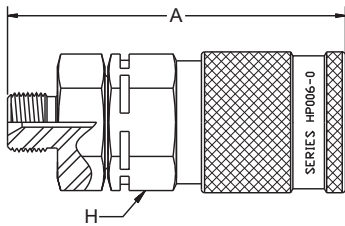

**HP006-0-A9,
 HP006-0-A12**

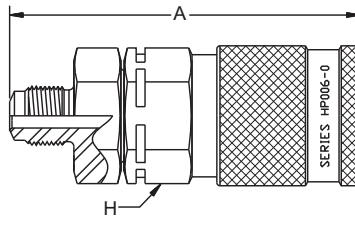

HP006-0-X13

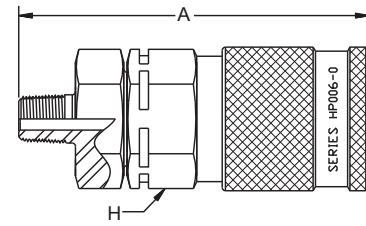

**HP006-0-NMB,
 HP006-0-NMC,
 HP006-0-NMD**

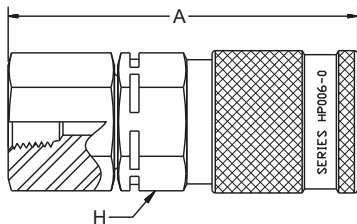



**HP006-0-NFB,
 HP006-0-NFC**

HP006

Nipple

Without Check Valve

Part Number	Connection Type	A Overall Length	H Hex Size	Maximum Working Pressure
#				
		inch	inch	psi
HP006-1-A9	Type "M" (9/16" - 18 threads)	1.98	0.75	30,000
HP006-1-A12	Type "M" (3/4" - 16 threads)	2.16	0.87	30,000
HP006-1-HM4	1/4" High Pressure Male	2.25	0.75	30,000
HP006-1-LM6	3/8" Medium Pressure Male	2.33	0.75	20,000
HP006-1-LM9	9/16" Medium Pressure Male	2.57	1.00	20,000
HP006-1-NMB	1/4" NPT Male	2.09	0.75	15,000
HP006-1-NMC	3/8" NPT Male	2.13	0.75	15,000
HP006-1-NMD	1/2" NPT Male	2.31	1.00	15,000
HP006-1-X13	Low Angle Face Seal (9/16" - 18 threads)	2.17	0.75	30,000

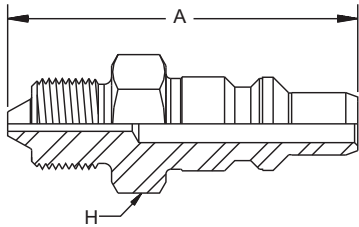

HP006-1-HM4

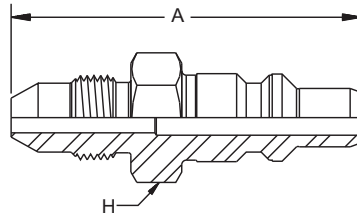

**HP006-1-LM6,
 HP006-1-LM9**

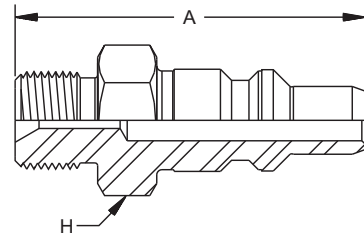

**HP006-1-A9,
 HP006-1-A12**

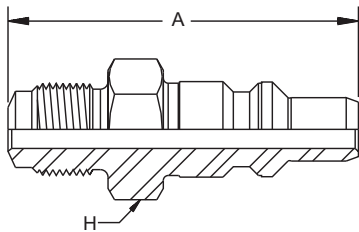

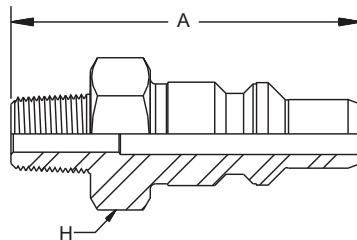

HP006-1-X13



**HP006-1-NMB,
 HP006-1-NMC,
 HP006-1-NMD**

HP006
Nipple
With Check Valve

Part Number	Connection Type	A Overall Length	H Hex Size	Maximum Working Pressure
#				
		inch	inch	psi
HP006-2-A9	Type "M" (9/16" - 18 threads)	3.28	1.19	30,000
HP006-2-A12	Type "M" (3/4" - 16 threads)	3.30	1.19	30,000
HP006-2-HM4	1/4" High Pressure Male	3.45	1.19	30,000
HP006-2-LM6	3/8" Medium Pressure Male	3.52	1.19	20,000
HP006-2-NFB	1/4" NPT Female	3.26	1.19	15,000
HP006-2-NFC	3/8" NPT Female	3.25	1.19	15,000
HP006-2-NMB	1/4" NPT Male	3.34	1.19	15,000
HP006-2-NMC	3/8" NPT Male	3.34	1.19	15,000
HP006-2-NMD	1/2" NPT Male	3.43	1.19	15,000
HP006-2-X13	Low Angle Face Seal (9/16" - 18 threads)	3.35	1.19	30,000

D

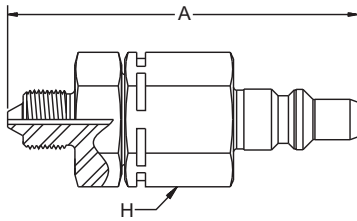

HP006-2-HM4

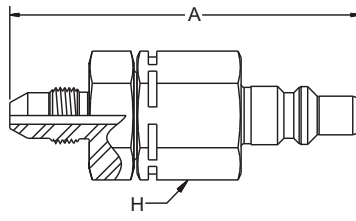

HP006-2-LM6

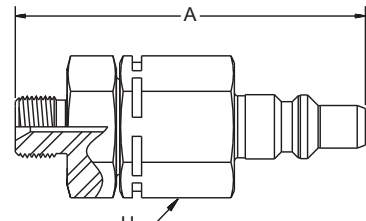

**HP006-2-A9,
 HP006-2-A12**

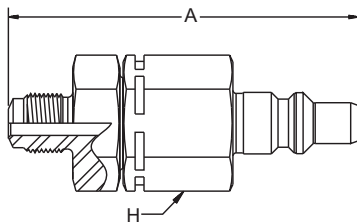

HP006-2-X13

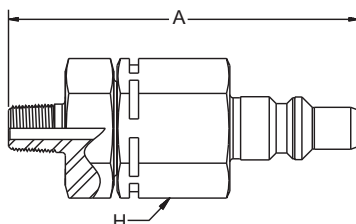

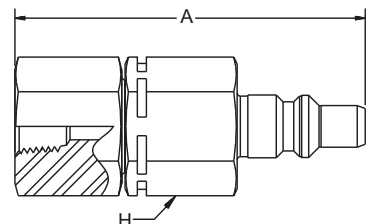

**HP006-2-NMB,
 HP006-2-NMC,
 HP006-2-NMB**



**HP006-2-NFB,
 HP006-2-NFC**

HP010

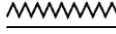
Coupler

Part Number	Connection Type	A Overall Length	H Hex Size	Maximum Working Pressure
#				
		inch	inch	psi
HP010-0-A12	Type "M" (3/4" - 16 threads)	4.00	1.62	20,000
HP010-0-A16	Type "M" (1" - 12 threads)	4.10	1.62	20,000
HP010-0-LM12	3/4" Medium Pressure Male	4.64	1.62	20,000
HP010-0-NFD	1/2" NPT Female	4.27	1.62	15,000
HP010-0-NMD	1/2" NPT Male	4.13	1.62	15,000
HP010-0-X23	Low Angle Face Seal (3/4" - 16 threads)	4.19	1.62	20,000

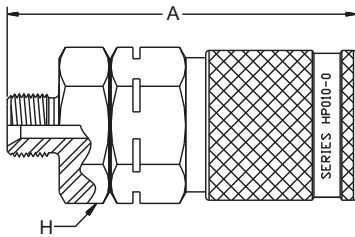

**HP010-0-A12,
 HP010-0-A16**

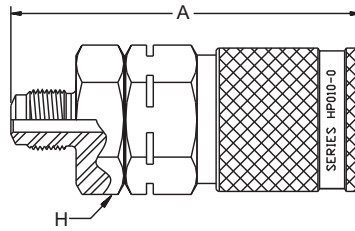

HP010-0-X23

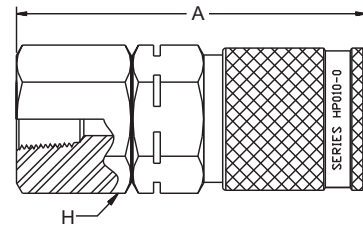

HP010-0-NFD

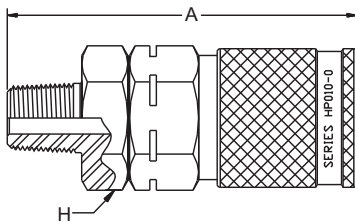

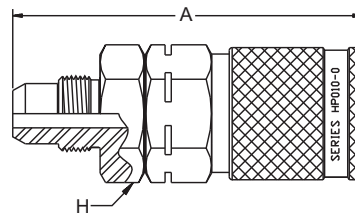

HP010-0-NMD



HP010-0-LM12

HP010
Nipple
Without Check Valve

Part Number	Connection Type	A Overall Length	H Hex Size	Maximum Working Pressure
#				
		inch	inch	psi
HP010-1-A12	Type "M" (3/4" - 16 threads)	2.40	1.06	20,000
HP010-1-A16	Type "M" (1" - 12 threads)	2.53	1.18	20,000
HP010-1-LM12	3/4" Medium Pressure Male	3.12	1.18	20,000
HP010-1-LM9	9/16" Medium Pressure Male	2.84	1.06	20,000
HP010-1-NMD	1/2" NPT Male	2.52	1.06	15,000
HP010-1-X23	Low Angle Face Seal (3/4" - 16 threads)	2.58	1.06	20,000

D

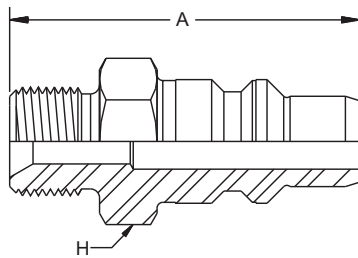

**HP010-1-A12,
 HP010-1-A16**

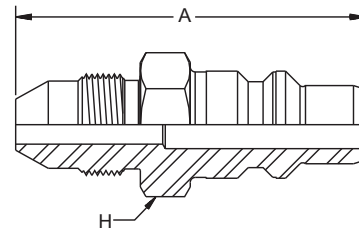

**HP010-1-LM9,
 HP010-1-LM12**

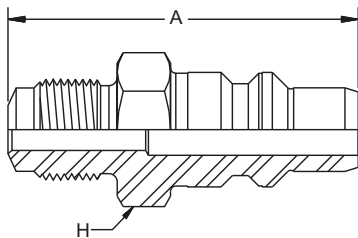

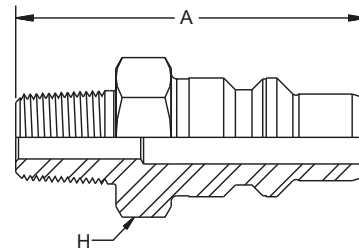

HP010-1-X23

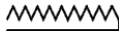

HP010-1-NMD

HP010
Nipple
With Check Valve

Part Number	Connection Type	A Overall Length	H Hex Size	Maximum Working Pressure
#				
		inch	inch	psi
HP010-2-A12	Type "M" (3/4" - 16 threads)	4.00	1.62	20,000
HP010-2-A16	Type "M" (1" - 12 threads)	4.08	1.62	20,000
HP010-2-NFD	1/2" NPT Female	4.14	1.62	15,000
HP010-2-NMD	1/2" NPT Male	4.13	1.62	15,000
HP010-2-X23	Low Angle Face Seal (3/4" - 16 threads)	4.18	1.62	20,000

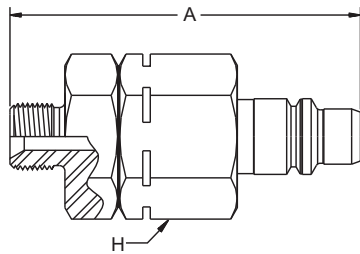

**HP010-2-A12,
 HP010-2-A16**

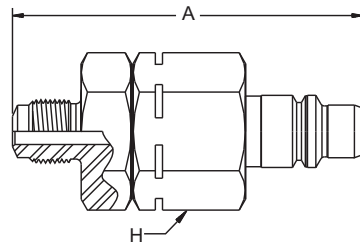

HP010-2-X23

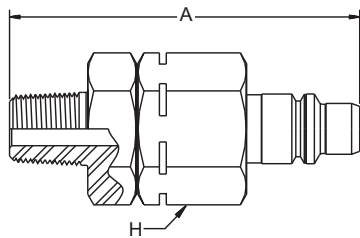

HP010-2-NMD

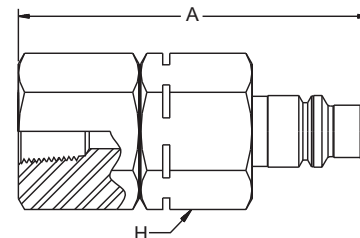

HP010-2-NFD

C Series

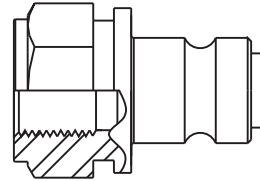
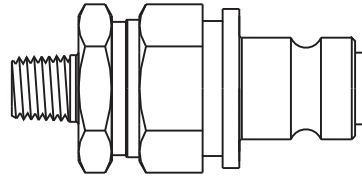
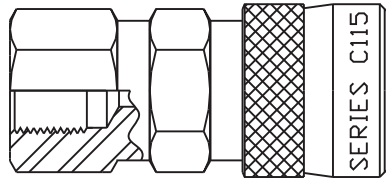

D

Features:

- Working pressures to 29,000 psi.
- Non-drip valving for clean, safe, trouble-free performance and minimal air inclusion.
- Built-in safety locking device to prevent accidental disconnect.
- Wide range of threaded styles NPT, BSP and “High Pressure”.
- Adaptors for ease of connection to high pressure hoses and fixed ports.
- Thread sizes from 1/8" to 3/8"
- Protective dust caps are included to prevent damage and fluid contamination in disconnected position.
- Rugged design and construction for long life in demanding applications.

Applications:

- Torque Tensioning
- Stud Tensioning
- Rescue
- Bearing Pullers
- Intensifiers
- Hydrostatic Testing
- Pumps
- Jacks
- Spreaders
- Cable Cutters
- Nut Splitters
- Pipe Coupling Swagers
- Presses
- Clamping Fictures
- Crimpers
- Blow-out Preventers

Type	Max. Working Pressure (psi)	Test Pressure (psi)	Nominal Thru Hole Diameter (in.)
C Series 115	14,500	21,800	0.11
C Series 116	21,800	29,200	0.11
C Series 125	29,800	36,300	0.11

NOTE: The choice of the threaded end form may limit the working pressure and the size of the thru hole in the coupling.

115

Coupler

Part Number	Connection Type	A Overall Length	H Hex Size	Maximum Working Pressure
#				
		inch	inch	psi
C10-115-1202	1/4" BSP Female (thru type)	2.30	0.94	14,500
C10-115-1222	1/4" BSP Female (with built-in locking device)	2.30	0.94	14,500
C10-115-1401	1/8" NPT Female	2.30	0.94	14,500
C10-115-1402	1/4" NPT Female	2.30	0.94	14,500
C10-115-1404	3/8" NPT Female	2.38	0.94	14,500
C10-115-1422	1/4" NPT Female (with built-in locking device)	2.30	0.94	14,500
C10-115-1452	1/4" NPT Male	2.45	0.94	14,500
C10-115-1454	3/8" NPT Male	2.45	0.94	14,500

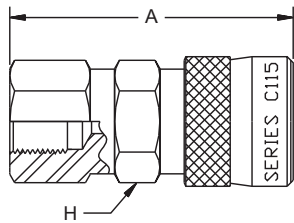

C10-115-1202

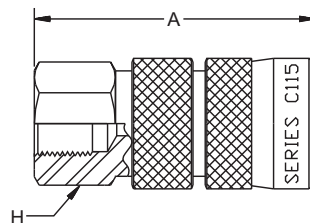

C10-115-1222

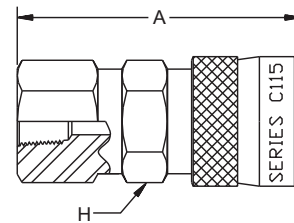

C10-115-1401

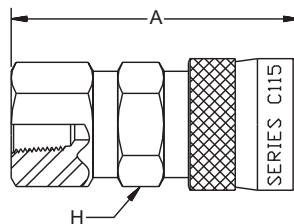

C10-115-1402

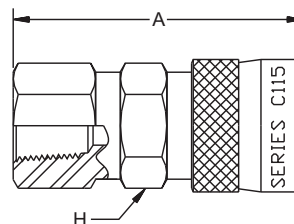

C10-115-1404

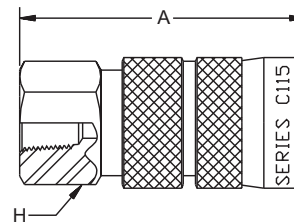

C10-115-1422

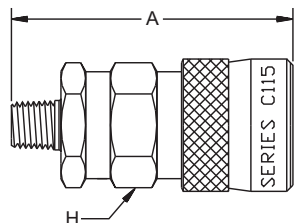

C10-115-1452

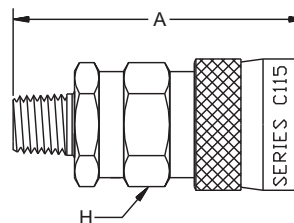

C10-115-1454

115 Nipple

Part Number	Connection Type	A Overall Length	H Hex Size	Maximum Working Pressure
#				
		inch	inch	psi
C10-115-6202	1/4" BSP Female	1.47	0.87	14,500
C10-115-6204	3/8" BSP Female	1.56	0.94	14,500
C10-115-6401	1/8" NPT Female	1.42	0.87	14,500
C10-115-6402	1/4" NPT Female	1.42	0.87	14,500
C10-115-6404	3/8" NPT Female	1.46	0.94	14,500
C10-115-6452	1/4" NPT Male	2.40	0.87	14,500
C10-115-6454	3/8" NPT Male	2.55	0.94	14,500

D

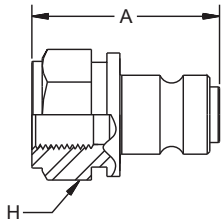

C10-115-6202

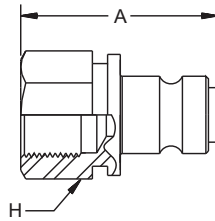

C10-115-6204

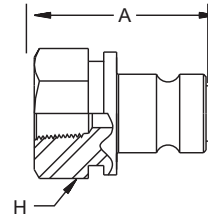

C10-115-6401

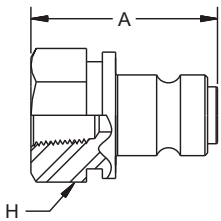

C10-115-6402

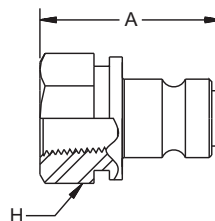

C10-115-6404

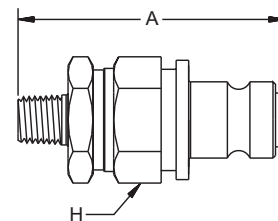

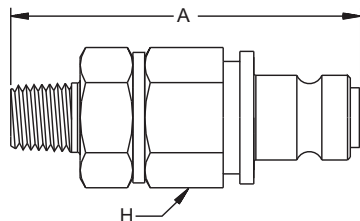

C10-115-6452



C10-115-6454

116

Coupler

Part Number	Connection Type	A Overall Length	H Hex Size	Maximum Working Pressure
#				
		inch	inch	psi
C10-116-1202	1/4" BSP Female	2.30	0.94	21,800
C10-116-1222	1/4" BSP Female (with built-in locking device)	2.30	0.94	21,800
C10-116-1402	1/4" NPT Female	2.30	0.94	15,000
C10-116-1422	1/4" NPT Female (with built-in locking device)	2.30	0.94	15,000

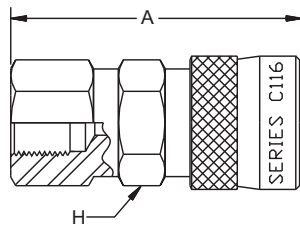

C10-116-1202

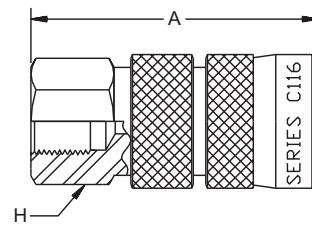

C10-116-1222

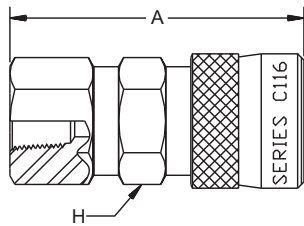

C10-116-1402

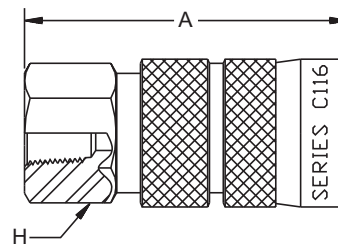

C10-116-1422

116 Nipple

Part Number	Connection Type	A Overall Length	H Hex Size	Maximum Working Pressure
#				
		inch	inch	psi
C10-116-5202	1/4" BSP Female (thru type)	1.47	0.87	21,800
C10-116-6202	1/4" BSP Female	1.47	0.87	21,800
C10-116-6402	1/4" NPT Female	1.41	0.87	15,000

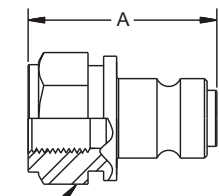

C10-116-5202

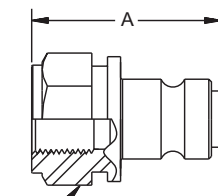

C10-116-6202

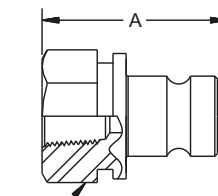

C10-116-6402

D

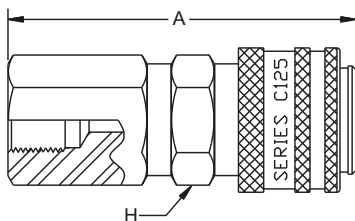

125 Coupler

Part Number	Connection Type	A Overall Length	H Hex Size	Maximum Working Pressure
#				
		inch	inch	psi
C10-125-1202	1/4" BSP Female	2.65	0.94	29,000



C10-125-1202

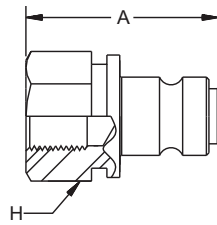

125 Nipple

Part Number	Connection Type	A Overall Length	H Hex Size	Maximum Working Pressure
#				
		inch	inch	psi
C10-125-5202	1/4" BSP Female (thru type)	1.50	0.87	29,000
C10-125-6202	1/4" BSP Female	1.50	0.87	29,000



**C10-125-5202,
 C10-125-6202**

Quick Coupling Adapters

#		A			
		Overall Length			
		inch	inch	inch	psi
C09-125-1680	1/4" BSP 120° external cone x 1/4" HP Male	1.72	0.67	0.67	29,000
C19-950-0029	1/4" BSP 120° external cone x 9/16" UNF Hose	1.48	0.67	0.67	29,000
C19-950-0062	1/4" BSP Rubber Metal Seal	0.08	0.81	0.81	14,500
C19-950-0064	3/8" BSP Rubber Metal Seal	0.08	0.94	0.94	14,500
C19-950-1600	1/4" BSP 120° external cone Blind Plug	1.07	0.67	0.67	29,000
C19-950-1601	1/4" BSP x 1/4" BSP with 120° external cones	1.76	0.08	0.08	29,000
C19-950-1602	1/4" BSP 120° external cone x 1/4" BSP 60° internal cone	1.54	0.83	0.83	29,000
C19-950-1622	1/4" BSP x 1/4" BSP with 60° internal cones	1.25	0.83	0.83	29,000
C19-950-1623	1/4" NPT Male x 1/4" BSP with 60° internal cone	1.27	0.83	0.83	14,500
C19-950-1680	Porting Block	1.80			29,000
HAHM4BM4	1/4" BSP with 60° internal cone x 1/4" HP Male	1.47	0.83	0.83	30,000

D

Note: Using A Rubber Metal Seal Reduces The Working Pressure To 14,500 psi

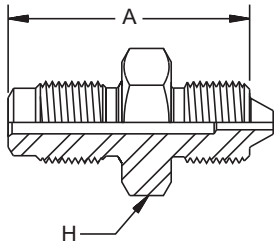

C09-125-1680

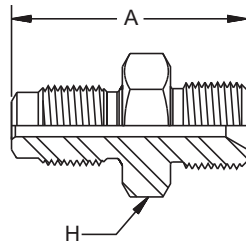

C19-950-0029

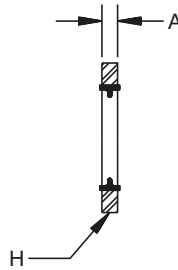

**C19-950-0062,
C19-950-0064**

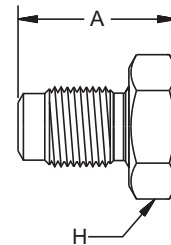

C19-950-1600

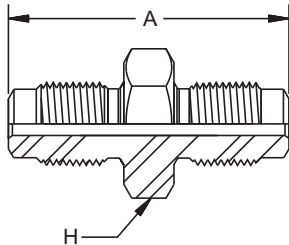

C19-950-1601

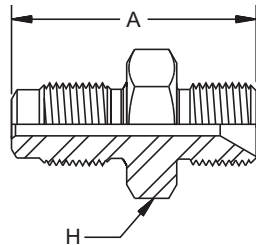

C19-950-1602

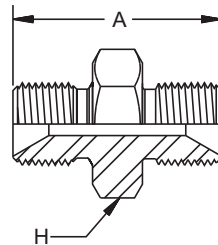

C19-950-1622

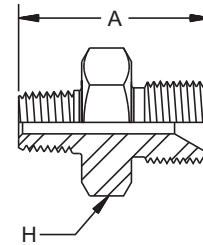

C19-950-1623

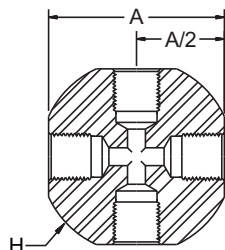

C19-950-1680

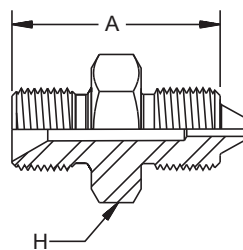

HAHM4BM4

WB Series

Applications

Parker's WB Series couplings are designed for equipment used in cleaning applications such as paint removal or mill scale. The 10,000 psi operating pressure of the WB series makes it ideal for applications that require a high pressure coupling with minimal pressure drop.

Features

- Push-to-Connect allows for quick, easy connections by eliminating the need to retract the sleeve to couple.
- Locking collets in the female half maintain 360 degree contact with male half to evenly distribute load and reduce brinelling.
- Zinc plating with yellow chromate finish resists corrosion.
- Straight through design allows for excellent flow with low pressure drop.
- Two knurled bands on the sleeve provide good gripping for operation of sleeve to disconnect.
- Sleeve Lock design prevents accidental disconnects.
- Stainless steel collets resist corrosion and provide smooth latching action.
- Teflon[®] backup washer ensures sealing integrity at high pressure.
- Induction hardened locking groove on the male half reduces wear and brinelling.
- Sleeve guard prevents accidental disconnect and seals the opening between the sleeve and the body from the environment.







Specifications

Body Size	1/2"
Temperature Range	-40°F to +250°F (-40°C to +121°C)
Maximum Operating Pressure	10,000 PSI (69 MPa)
Rated Flow	45 GPM (170 LPM)

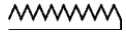
125

WB Coupler



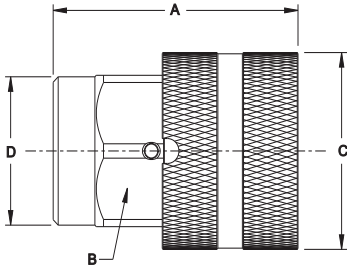

Part Number	Connection Type	A Overall Length	B Hex Size	C Largest Diameter	D Turned Diameter	Maximum Working Pressure
#						
WB-501-8FP	1/2-14 NPTF	inch 2.10	inch 1.25	inch 1.25	inch 1.25	psi 10,000



WB-501-8FP

125

WB Nipple

Part Number	Connection Type	E Overall Length	F Exposed Length	G Hex Size	H Largest Diameter	Maximum Working Pressure
#						
WB-502-8FP	1/2-14 NPTF	inch 2.35	inch 1.26	inch 1.13	inch 1.63	psi 10,000

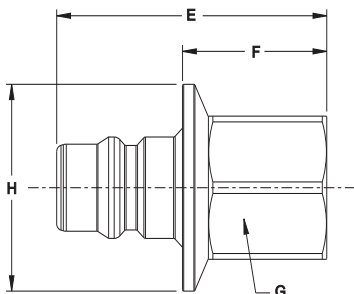

WB-502-8FP

D