

Needle Valves

Low Pressure

10V & SW Series

Pressures to 15,000 psi (1034 bar)

Since 1945 Parker Autoclave Engineers has designed and built premium quality valves, fittings and tubing. This commitment to engineering and manufacturing excellence has earned Parker Autoclave a reputation for reliable efficient product performance. Parker Autoclave Engineers has long been established as the world leader in high pressure fluid handling components for the chemical/petrochemical, research, and oil and gas industries.

Low Pressure Valve Features:

- 10V Series valve design provides in-line tube connections for 1/4" to 1/2" tube sizes.
- SW Series valve design provides increased flow capabilities.
- Tubing sizes from 1/8" to 1/2".
- Rising stem/barstock body design.
- Non-rotating stem prevents stem/seat galling.
- Metal-to-metal seating achieves bubble-tight shut-off, longer stem/seat life in abrasive flow, greater durability for repeated on/off cycles and excellent corrosion resistance.
- PTFE encapsulated packing provides dependable stem and body sealing.
- Stem sleeve and packing gland materials have been selected to achieve extended thread cycle life and reduced handle torque.
- Choice of Vee or Regulating stem tips.
- Available in five body patterns.

Parker Autoclave Engineers valves are complemented by a complete line of low pressure fittings, tubing, check valves and line filters. The 10V and SW series use Parker Autoclave Engineers' SpeedBite connection. This single-ferrule compression sleeve connection delivers fast, easy make-up and reliable bubble-tight performance in liquid or gas service.



www.autoclave.com

Needle Valves - 10V & SW Series
Low Pressure

Valve Series - 10V Series

Pressures to 15,000 psi (1034 bar)

Tube Outside Diameter Size Inches	Connection Type	Orifice Size Inches (mm)	Rated C_V^*	Pressure Rating psi (bar) @ Room Temperature**
1/8	W125	0.094 (2.39)	0.12	15,000 (1034)
1/4	W250	0.125 (3.18)	0.20	15,000 (1034)
3/8	W375	0.125 (3.18)	0.20	15,000 (1034)
1/2	SW500	0.250 (6.35)	0.86	10,000 (690)

Notes:

* C_V values shown are for 2-way straight valve pattern. For 2-way angle patterns, increase C_V value 50%. (Based on water)

** For complete temperature ratings see pressure/temperature rating guide in Technical Information section.

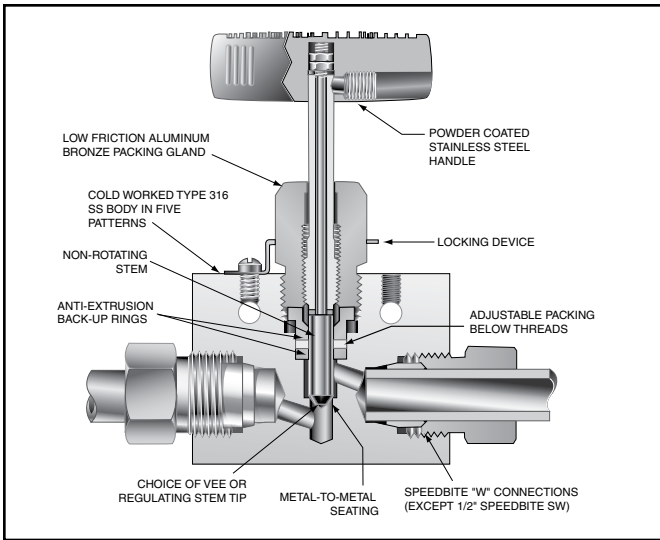
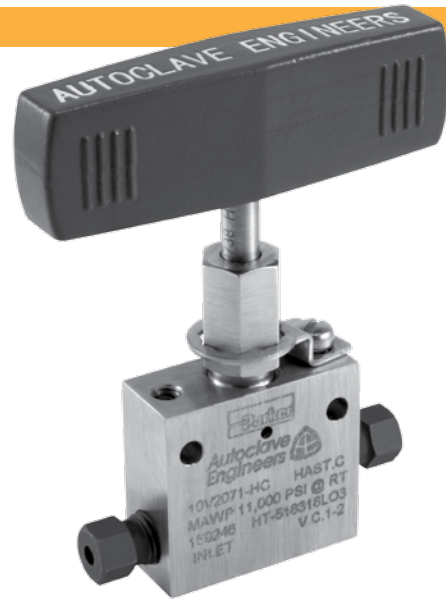

To ensure proper fit use Autoclave tubing

Generalized Flow Coefficient Curves (C_V)

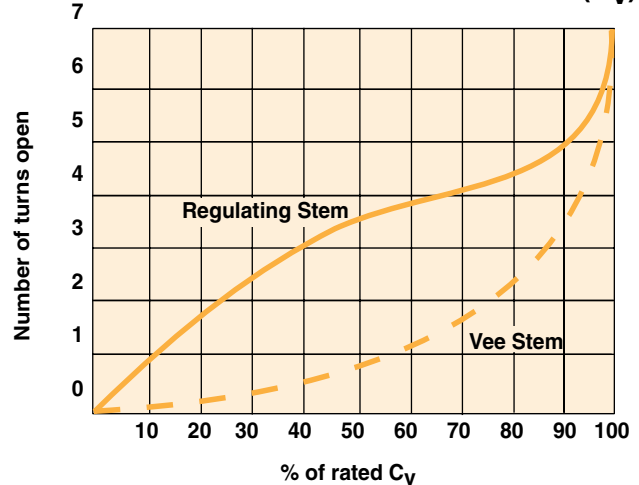

Ordering Procedure

For complete information on available stem types, optional connections and additional valve options, see Needle Valve Options section or contact your Sales Representative. 10V Series valves are furnished complete with connection components, unless otherwise specified.

Typical catalog number: **10V4071**

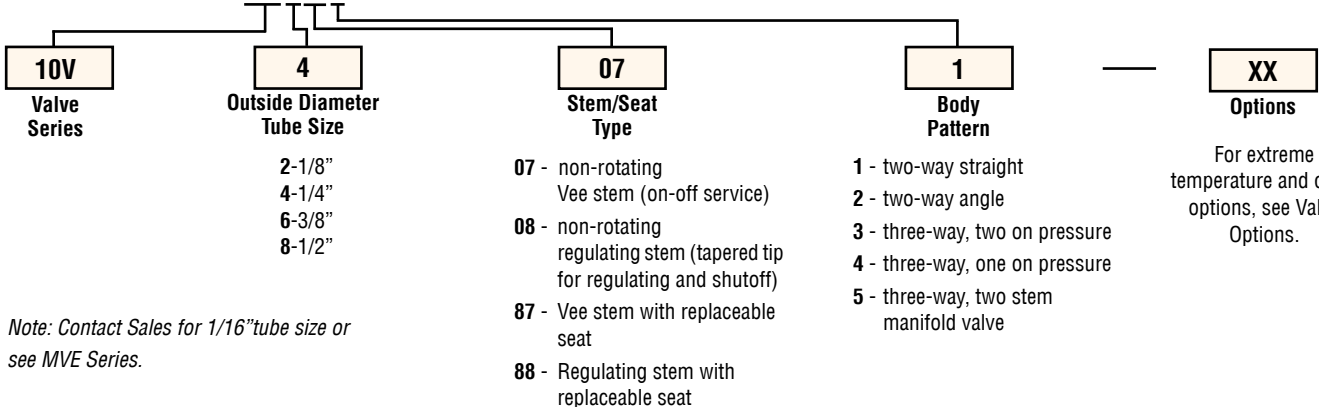

Note: Contact Sales for 1/16" tube size or see MVE Series.

Valve Options

Extreme Temperatures

Standard Parker Autoclave valves with PTFE packing may be operated to 450°F (232°C). High temperature packing and/or extended stuffing box is available for service from -100°F (-73°C) to 650°F (343°C) by adding the following suffixes to catalog order number.†

TG standard valve with PTFE glass packing to 600°F (316°C).
GY standard valve with graphite braided yarn packing to 650°F (343°C).

B standard valve with cryogenic trim materials and Teflon packing to -100°F (-73°C).

† Parker Autoclave Engineers does not recommend compression sleeve connections below -100°F (-73°C) or above 650°F (343°C). For additional valve options, contact your Sales Representative.

Valve Maintenance

Repair Kits: add "R" to the front of valve catalog number for proper repair kit.
 (Example: **R10V4071**)

Valve Bodies: Valve bodies are available. Order using the eight (8) digit part number found on the valve drawing or contact your Sales Representative for information.

Consult your Parker Autoclave Engineers representative for pricing on repair kits and valve bodies. Refer to the Tools, Installation, Operation and Maintenance section for proper maintenance procedures.

Catalog Number	Stem Type	Outside Diameter Tube	Orifice Diameter	Dimensions - inches (mm)												Block Thickness	Valve Pattern
				A	B	C	D	D ₁	E	F	G	G ₁	H*	M	N		

2-Way Straight

10V2071	VEE	1/8**	0.094	1.50	0.75	0.31	1.06	0.81	1.38	3.00	0.62	0.17	3.75	0.56	0.31	0.62	See Figure 1
10V2081	REG	(3.18)	(2.39)	(38.10)	(19.05)	(7.87)	(26.92)	(20.57)	(35.05)	(76.20)	(15.75)	(4.32)	(95.25)	(14.22)	(7.87)	(15.75)	
10V4071	VEE	1/4	0.125	2.00	1.00	0.56	1.19		1.69	3.00	0.97	0.22	4.44	0.69	0.38	1.00	
10V4081	REG	(6.35)	(3.18)	(50.80)	(25.40)	(14.22)	(30.23)		(42.93)	(76.20)	(24.64)	(5.59)	(112.78)	(17.53)	(9.65)	(25.40)	
10V6071	VEE	3/8	0.125	2.00	1.00	0.62	1.19		1.69	3.00	0.97	0.22	4.31	0.69	0.38	1.00	
10V6081	REG	(9.53)	(3.18)	(50.80)	(25.40)	(15.75)	(30.23)		(42.93)	(76.20)	(24.64)	(5.59)	(109.47)	(17.53)	(9.65)	(25.40)	
10V8071	VEE	1/2	0.250	2.50	1.25	0.53	1.25		1.81	3.00	0.97	0.22	4.44	0.69	0.38	1.00	
10V8081	REG	(12.70)	(6.35)	(63.50)	(31.75)	(13.46)	(31.75)		(45.97)	(76.20)	(24.64)	(5.59)	(112.78)	(17.53)	(9.65)	(25.40)	

2-Way Angle

10V2072	VEE	1/8	0.094	1.50	0.75	0.31	0.81		1.56	3.00	0.62	0.17	3.94	0.56	0.31	0.62	See Figure 2
10V2082	REG	(3.18)	(2.39)	(38.1)	(19.05)	(7.87)	(20.57)		(39.62)	(76.20)	(15.75)	(4.32)	(100.08)	(12.70)	(7.87)	(15.75)	
10V4072	VEE	1/4	0.125	2.00	1.00	0.56	1.19		2.19	3.00	0.97	0.22	4.81	0.69	0.31	1.00	
10V4082	REG	(6.35)	(3.18)	(50.80)	(25.40)	(14.2)	(30.23)		(55.63)	(76.20)	(24.64)	(5.59)	(122.17)	(17.53)	(7.87)	(25.40)	
10V6072	VEE	3/8	0.125	2.00	1.00	0.62	1.19		2.19	3.00	0.97	0.22	4.81	0.69	0.31	1.00	
10V6082	REG	(9.53)	(3.18)	(50.80)	(25.40)	(15.7)	(30.23)		(55.63)	(76.20)	(24.64)	(5.59)	(122.17)	(17.53)	(7.87)	(25.40)	
10V8072	VEE	1/2	0.250	2.50	1.25	0.53	1.25		2.50	3.00	0.97	0.22	5.06	0.69	0.38	1.00	
10V8082	REG	(12.70)	(6.35)	(63.50)	(31.75)	(13.5)	(31.75)		(63.50)	(76.20)	(24.64)	(5.59)	(128.52)	(17.53)	(9.65)	(25.40)	

3-Way / 2 on Pressure

10V2073	VEE	1/8**	0.094	1.50	0.75	0.31	1.06	0.81	1.69	3.00	0.62	0.17	4.06	0.56	0.31	0.62	See Figure 3
10V2083	REG	(3.18)	(2.39)	(38.10)	(19.05)	(7.87)	(26.92)	20.57	(42.93)	(76.20)	(15.75)	(4.32)	(103.12)	(12.70)	(7.87)	(15.75)	
10V4073	VEE	1/4	0.125	2.00	1.00	0.56	1.19		2.19	3.00	0.97	0.22	4.81	0.69	0.38	1.00	
10V4083	REG	(6.35)	(3.18)	(50.80)	(25.40)	(14.22)	(30.23)		(55.63)	(76.20)	(24.64)	(5.59)	(122.17)	(17.53)	(9.65)	(25.40)	
10V6073	VEE	3/8	0.125	2.00	1.00	0.62	1.19		2.19	3.00	0.97	0.22	4.81	0.69	0.38	1.00	
10V6083	REG	(9.53)	(3.18)	(50.80)	(25.40)	(15.75)	(30.23)		(55.63)	(76.20)	(24.64)	(5.59)	(122.17)	(17.53)	(9.65)	(25.40)	
10V8073	VEE	1/2	0.250	2.50	1.25	0.53	1.19		2.44	3.00	0.97	0.22	5.06	0.69	0.38	1.00	
10V8083	REG	(12.70)	(6.35)	(63.50)	(31.75)	(13.46)	(30.23)		(61.98)	(76.20)	(24.64)	(5.59)	(128.52)	(17.53)	(9.65)	(25.40)	

G - Packing gland mounting hole drill size

G₁ - Bracket mounting hole size

Panel mounting drill size: 0.22" all valves.

* H Dimension is with stem in closed position.

** 1/8" straight and 3-Way/2 on pressure valves have offset tube connections.

For prompt service, Autoclave stocks select products. Consult factory.

All dimensions for reference only and subject to change.

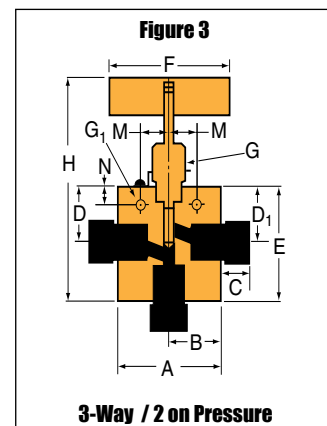
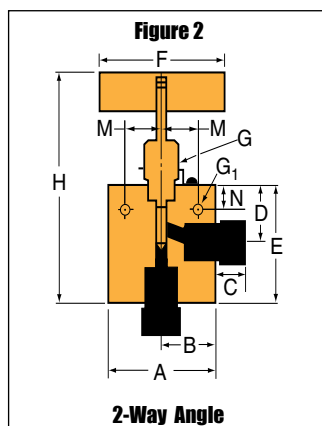
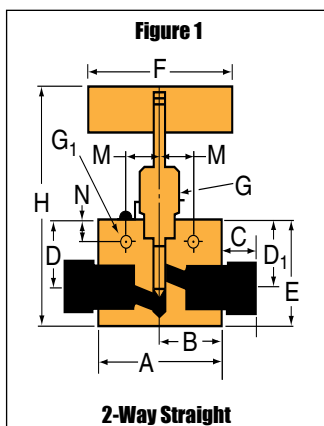

Catalog Number	Stem Type	Outside Diameter Tube	Orifice Diameter	Dimensions - inches (mm)												Block Thickness	Valve Pattern
				A	B	C	D	D ₁	E	F	G	G ₁	H*	M	N		

3-Way / 1 on Pressure

10V2074	VEE	1/8	0.094	1.50	0.75	0.31	0.81		1.56	3.00	0.62	0.17	3.94	0.56	0.31	0.62	See Figure 4
10V2084	REG	(3.18)	(2.39)	(38.1)	(19.05)	(7.87)	(20.57)		(39.62)	(76.20)	(15.75)	(4.32)	(100.08)	(12.70)	(7.87)	(15.7)	
10V4074	VEE	1/4	0.125	2.00	1.00	0.56	1.19		2.19	3.00	0.97	0.22	4.81	0.69	0.38	1.00	
10V4084	REG	(6.35)	(3.18)	(50.8)	(25.40)	(14.22)	(30.23)		(55.63)	(76.20)	(24.64)	(5.59)	(122.17)	(17.53)	(9.65)	(25.40)	
10V6074	VEE	3/8	0.125	2.00	1.00	0.62	1.19		2.19	3.00	0.97	0.22	4.81	0.69	0.38	1.00	
10V6084	REG	(9.53)	(3.18)	(50.8)	(25.40)	(15.75)	(30.23)		(55.63)	(76.20)	(24.64)	(5.59)	(122.17)	(17.53)	(9.65)	(25.40)	
10V8074	VEE	1/2	0.250	2.50	1.25	0.53	1.19		2.44	3.00	0.97	0.22	5.06	0.69	0.38	1.00	
10V8084	REG	(12.70)	(6.35)	(63.5)	(31.75)	(13.46)	(30.23)		(61.98)	(76.20)	(24.64)	(5.59)	(128.52)	(17.53)	(9.65)	(25.40)	

2-Way Angle / Replaceable Seat

10V2872	VEE	1/8	0.094	1.50	0.75	0.31	0.81	1.28	1.56	3.00	0.62	0.17	4.50	0.56	0.31	0.62	See Figure 5
10V2882	REG	(3.18)	(2.39)	(38.10)	(19.05)	(7.87)	(20.57)	(32.51)	(39.62)	(76.20)	(15.75)	(4.32)	(114.30)	(12.70)	(7.87)	(15.75)	
10V4872	VEE	1/4	0.125	2.00	1.00	0.56	1.12	2.13	2.25	3.00	0.97	0.22	6.00	0.69	0.38	1.00	
10V4882	REG	(6.35)	(3.18)	(50.80)	(25.40)	(14.22)	(28.45)	(54.10)	(57.15)	(76.20)	(24.64)	(5.59)	(152.40)	(17.53)	(9.65)	(25.40)	
10V6872	VEE	3/8	0.125	2.00	1.00	0.62	1.12	2.28	2.25	3.00	0.97	0.22	6.00	0.69	0.38	1.00	
10V6882	REG	(9.53)	(3.18)	(50.80)	(25.40)	(15.75)	(28.45)	(57.91)	(57.15)	(76.20)	(24.64)	(5.59)	(152.40)	(17.53)	(9.65)	(25.40)	
10V8872	VEE	1/2	0.250	2.50	1.25	0.53	1.00	2.50	2.38	3.00	0.97	0.28	6.06	0.69	0.38	1.00	
10V8882	REG	(12.70)	(6.35)	(63.50)	(31.75)	(13.46)	(25.45)	(63.50)	(60.45)	(76.20)	(24.64)	(7.11)	(153.92)	(17.53)	(9.65)	(25.40)	

3-Way / 2-Stem Manifold

10V2075	VEE	1/8	0.094	1.50	0.75	0.31	1.12	0.81	2.25	3.00	0.62	0.17	4.63	0.56	0.31	0.62	See Figure 6
10V2085	REG	(3.18)	(2.39)	(38.10)	(19.05)	(7.87)	(28.45)	(20.57)	(57.15)	(76.20)	(15.75)	(4.32)	(117.60)	(12.70)	(7.87)	(15.7)	
10V4075	VEE	1/4	0.125	2.00	1.00	0.56	1.69	1.09	3.38	3.00	0.97	0.22	5.82	0.69	0.38	1.00	
10V4085	REG	(6.35)	(3.18)	(50.80)	(25.40)	(14.22)	(42.93)	(27.69)	(85.85)	(76.20)	(24.64)	(5.59)	(147.83)	(17.53)	(9.65)	(25.40)	
10V6075	VEE	3/8	0.125	2.00	1.00	0.62	1.69	1.09	3.38	3.00	0.97	0.22	5.82	0.69	0.38	1.00	
10V6085	REG	(9.53)	(3.18)	(50.80)	(25.40)	(15.75)	(42.93)	(27.69)	(85.85)	(76.20)	(24.64)	(5.59)	(147.83)	(17.53)	(9.65)	(25.40)	
10V8075	VEE	1/2	0.250	2.50	1.25	0.53	1.69	1.03	3.38	3.00	0.97	0.22	5.82	0.69	0.38	1.00	
10V8085	REG	(12.70)	(6.35)	(63.50)	(31.75)	(13.46)	(42.93)	(26.16)	(85.85)	(76.20)	(24.64)	(5.59)	(147.83)	(17.53)	(9.65)	(25.40)	

G - Packing gland mounting hole drill size
 G₁ - Bracket mounting hole size
 Panel mounting drill size: 0.22" all valves.

* H Dimension is with stem in closed position.
 All dimensions for reference only and subject to change.

For prompt service, Autoclave stocks select products.
 Consult factory.

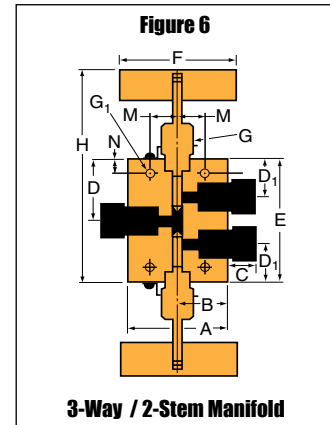
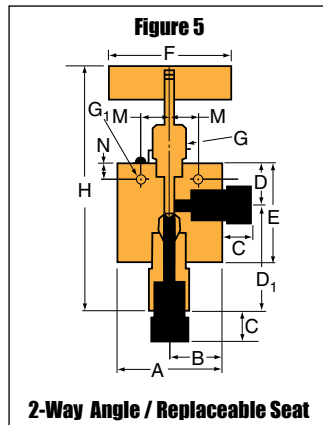
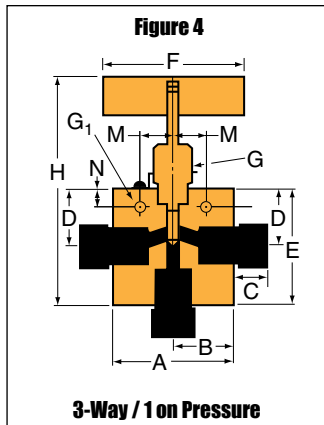

Needle Valves - SW Series

Pressures to 15,000 psi (1034 bar)

Tube Outside Diameter Size Inches	Connection Type	Orifice Size Inches (mm)	Rated C_V^*	Pressure Rating psi (bar) @ Room Temperature**
1/8	W125	Refer to 10V Series Valves	—	—
1/4	SW250	0.188 (4.77)	0.65	15,000 (1034)
3/8	SW375	0.250 (6.35)	0.95	15,000 (1034)
1/2	SW500	0.375 (9.52)	1.90	10,000 (690)

Notes:

* C_V values shown are for 2-way straight valve pattern. For 2-way angle patterns, increase C_V value 50%. (Based on water)

** For complete temperature ratings see pressure/temperature rating guide in Technical Information section.

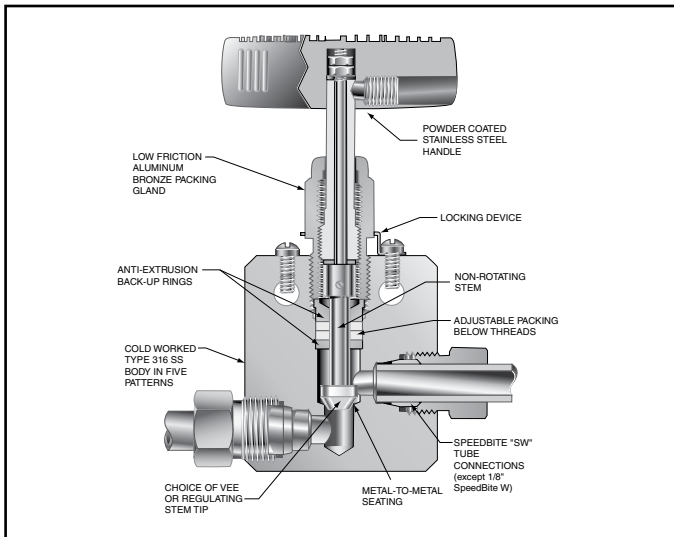

To ensure proper fit use Autoclave tubing

Generalized Flow Coefficient Curves (C_V)

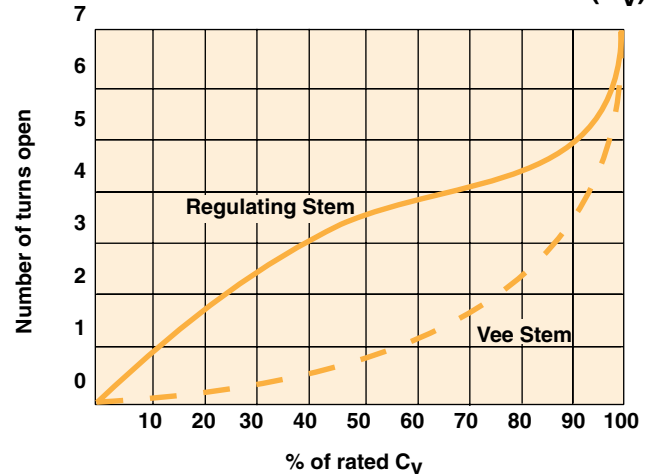

Ordering Procedure

For complete information on available stem types, optional connections and additional valve options, see Needle Valve Options section or contact your Sales Representative. SW Series valves are furnished complete with connection components, unless otherwise specified.

Typical catalog number: **SW4071**

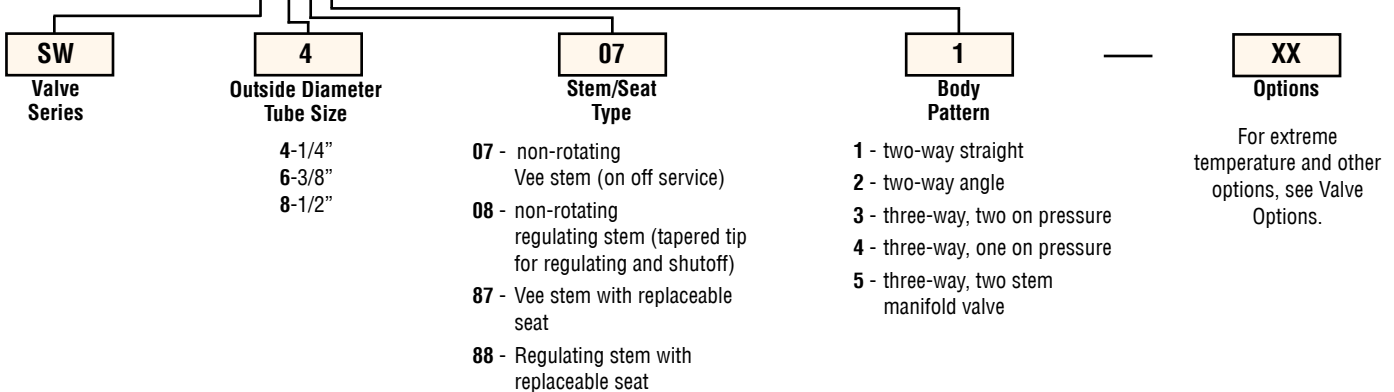

Valve Options

Extreme Temperatures

Standard Parker Autoclave valves with PTFE packing may be operated to 450°F (232°C). High temperature packing and/or extended stuffing box are available for service from -100°F (-73°C) to 650°F (343°C) by adding the following suffixes to catalog order number.†

TG standard valve with PTFE glass packing to 600°F (316°C).

GY standard valve with graphite braided yarn packing to 650°F (343°C).

B standard valve with cryogenic trim materials and Teflon packing to -100°F (-73°C).

† Parker Autoclave Engineers does not recommend compression sleeve connections below -100°F (-73°C) or above 650°F (343°C). For additional valve options, contact your Sales Representative.

Valve Maintenance

Repair Kits: add "R" to the front of valve catalog number for proper repair kit.
(Example: **RSW4071**)

Valve Bodies: Valve bodies are available. Order using the eight (8) digit part number found on the valve drawing or contact your Sales Representative for information.

Consult your Parker Autoclave Engineers representative for pricing on repair kits and valve bodies. Refer to the Tools, Installation, Operation and Maintenance section for proper maintenance procedures.

Catalog Number	Stem Type	Outside Diameter Tube	Orifice Diameter	Dimensions - inches (mm)												Block Thickness	Valve Pattern
				A	B	C	D	D ₁	E	F	G	G ₁	H*	M	N		

2-Way Straight

SW4071	VEE	1/4	0.187	2.00	1.00	0.38	1.62	1.19	2.00	3.00	0.75	0.22	4.50	0.62	0.38	0.75	See Figure 1	
SW4081	REG		(6.35)	(4.75)	(50.80)	(25.40)	(9.65)	(41.15)	(30.23)	(50.80)	(76.20)	(19.05)	(5.59)	(114.30)	(15.75)	(9.65)		(19.05)
SW6071	VEE	3/8	0.250	2.00	1.00	0.47	1.62	1.19	2.00	3.00	0.75	0.22	4.50	0.62	0.38	0.75		
SW6081	REG		(9.53)	(6.35)	(50.80)	(25.40)	(11.94)	(41.15)	(30.23)	(50.80)	(76.20)	(19.05)	(5.59)	(114.30)	(15.75)	(9.65)		(19.05)
SW8071	VEE	1/2	0.375	2.50	1.25	0.53	2.38	1.75	2.88	4.00	1.00	0.34	5.95	0.69	0.50	1.00		
SW8081	REG		(12.70)	(9.53)	(63.50)	(31.75)	(13.46)	(60.45)	(44.45)	(73.15)	(101.60)	(25.40)	(8.64)	(151.37)	(17.53)	(12.70)		(25.40)

2-Way Angle

SW4072	VEE	1/4	0.187	2.00	1.00	0.38	1.19		2.43	3.00	0.75	0.22	5.00	0.62	0.38	0.75	See Figure 2	
SW4082	REG		(6.35)	(4.75)	(50.80)	(25.40)	(9.65)	(30.23)		(61.72)	(76.20)	(19.05)	(5.59)	(127.00)	(15.75)	(9.65)		(19.05)
SW6072	VEE	3/8	0.250	2.00	1.00	0.47	1.19		2.19	3.00	0.75	0.22	5.00	0.62	0.38	0.75		
SW6082	REG		(9.53)	(6.35)	(50.80)	(25.40)	(11.94)	(30.23)		(55.63)	(76.20)	(19.05)	(5.59)	(127.00)	(15.75)	(9.65)		(19.05)
SW8072	VEE	1/2	0.375	2.50	1.25	0.53	1.75		3.38	4.00	1.00	0.34	6.45	0.69	0.50	1.00		
SW8082	REG		(12.70)	(9.53)	(63.50)	(31.75)	(13.46)	(44.45)		(85.85)	(101.60)	(25.40)	(8.64)	(163.83)	(17.53)	(12.70)		(25.40)

3-Way / 2 on Pressure

SW4073	VEE	1/4	0.187	2.00	1.00	0.38	1.62	1.19	2.62	3.00	0.75	0.22	5.18	0.62	0.38	0.75	See Figure 3	
SW4083	REG		(6.35)	(4.75)	(50.80)	(25.40)	(9.65)	(41.15)	(30.23)	(66.55)	(76.20)	(19.05)	(5.59)	(131.57)	(15.75)	(9.65)		(19.05)
SW6073	VEE	3/8	0.250	2.00	1.00	0.47	1.62	1.19	2.62	3.00	0.75	0.22	5.13	0.62	0.38	0.75		
SW6083	REG		(9.53)	(6.35)	(50.80)	(25.40)	(11.94)	(41.15)	(30.23)	(66.55)	(76.20)	(19.05)	(5.59)	(130.30)	(15.75)	(9.65)		(19.05)
SW8073	VEE	1/2	0.375	2.50	1.25	0.53	2.38	1.75	3.62	4.00	1.00	0.34	6.70	0.69	0.50	1.00		
SW8083	REG		(12.70)	(9.53)	(63.50)	(31.75)	(13.46)	(60.45)	(44.45)	(91.95)	(101.60)	(25.40)	(8.64)	(170.18)	(17.53)	(12.70)		(25.40)

G - Packing gland mounting hole drill size
G₁ - Bracket mounting hole size
Panel mounting drill size: 0.22" all valves.

* H Dimension is with stem in closed position.
All dimensions for reference only and subject to change.

For prompt service, Autoclave stocks select products. Consult factory.

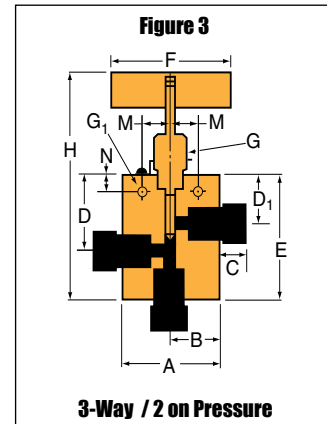
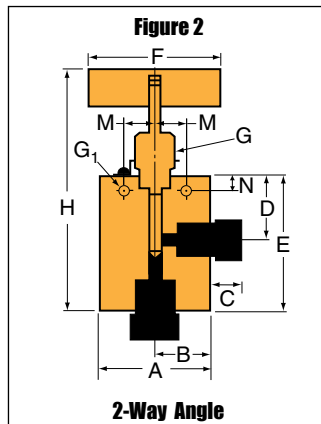
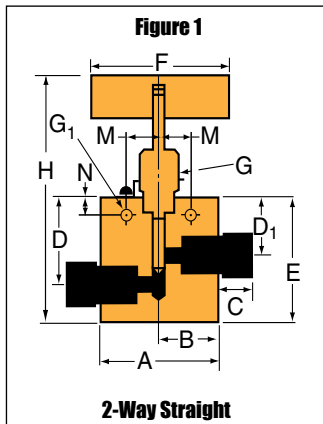

Catalog Number	Stem Type	Outside Diameter Tube	Orifice Diameter	Dimensions -inches (mm)												Block Thickness	Valve Pattern
				A	B	C	D	D ₁	E	F	G	G ₁	H*	M	N		

3-Way / 1 on Pressure

SW4074	VEE	1/4	0.187	2.00	1.00	0.38	1.19		2.43	3.00	0.75	0.22	5.00	0.62	0.38	0.75	See Figure 4
SW4084	REG	(6.35)	(4.75)	(50.80)	(25.40)	(9.65)	(30.23)		(61.72)	(76.20)	(19.05)	(5.59)	(127.00)	(15.75)	(9.65)	(19.05)	
SW6074	VEE	3/8	0.250	2.00	1.00	0.47	1.19		2.43	3.00	0.75	0.22	5.00	0.62	0.38	0.75	
SW6084	REG	(9.53)	(6.35)	(50.80)	(25.40)	(11.94)	(30.23)		(61.72)	(76.20)	(19.05)	(5.59)	(127.00)	(15.75)	(9.65)	(19.05)	
SW8074	VEE	1/2	0.375	2.50	1.25	0.53	1.75		3.38	4.00	1.00	0.34	6.45	0.69	0.50	1.00	
SW8084	REG	(12.70)	(9.53)	(63.50)	(31.75)	(13.46)	(44.45)		(85.85)	(101.60)	(25.40)	(8.64)	(163.83)	(17.53)	(12.70)	(25.40)	

2-Way Angle / Replaceable Seat

SW4872	VEE	1/4	0.187	2.00	1.00	0.38	1.19	1.88	2.25	3.00	0.75	0.22	5.75	0.62	0.38	0.75	See Figure 5
SW4882	REG	(6.35)	(4.75)	(50.80)	(25.40)	(9.65)	(30.23)	(47.75)	(57.15)	(76.20)	(19.05)	(5.59)	(146.05)	(15.75)	(9.65)	(19.05)	
SW6872	VEE	3/8	0.250	2.00	1.00	0.47	1.19	2.19	2.25	3.00	0.75	0.22	5.75	0.62	0.38	0.75	
SW6882	REG	(9.53)	(6.35)	(50.80)	(25.40)	(11.94)	(30.23)	(55.62)	(57.15)	(76.20)	(19.05)	(5.59)	(146.05)	(15.75)	(9.65)	(19.05)	
SW8872	VEE	1/2	0.375	2.50	1.25	0.53	1.75	2.50	3.25	4.00	1.00	0.34	7.51	0.69	0.50	1.00	
SW8882	REG	(12.70)	(9.53)	(63.50)	(31.75)	(13.46)	(44.45)	(63.50)	(82.55)	(101.60)	(25.40)	(8.64)	(190.75)	(17.53)	(12.70)	(25.40)	

3-Way / 2-Stem Manifold

SW4075	VEE	1/4	0.187	2.00	1.00	0.38	1.68	1.19	3.38	3.00	0.75	0.22	5.94	0.62	0.38	0.75	See Figure 6
SW4085	REG	(6.35)	(4.75)	(50.80)	(25.40)	(9.65)	(42.67)	(30.23)	(85.85)	(76.20)	(19.05)	(5.59)	(150.88)	(15.75)	(9.65)	(19.05)	
SW6075	VEE	3/8	0.250	2.00	1.00	0.47	1.68	1.19	3.38	3.00	0.75	0.22	5.94	0.62	0.38	0.75	
SW6085	REG	(9.53)	(6.35)	(50.80)	(25.40)	(11.94)	(42.67)	(30.23)	(85.85)	(76.20)	(19.05)	(5.59)	(150.88)	(15.75)	(9.65)	(19.05)	
SW8075	VEE	1/2	0.375	2.50	1.25	0.53	2.56	1.75	5.12	4.00	1.00	0.34	8.20	0.69	0.50	1.00	
SW8085	REG	(12.70)	(9.53)	(63.50)	(31.75)	(13.46)	(65.02)	(44.45)	(130.05)	(101.60)	(25.40)	(8.64)	(208.28)	(17.53)	(12.70)	(25.40)	

G - Packing gland mounting hole drill size
G₁ - Bracket mounting hole size
Panel mounting drill size: 0.22" all valves.

* H Dimension is with stem in closed position.
All dimensions for reference only and subject to change.

For prompt service, Autoclave stocks select products. Consult factory.

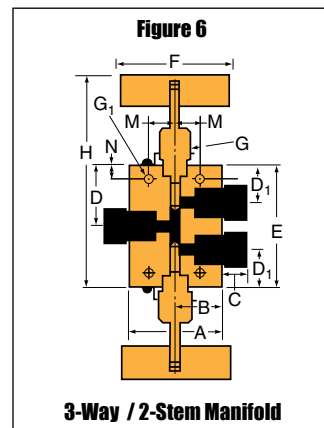
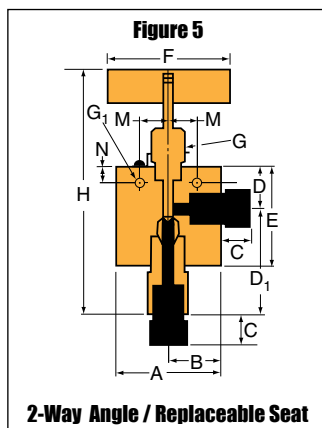
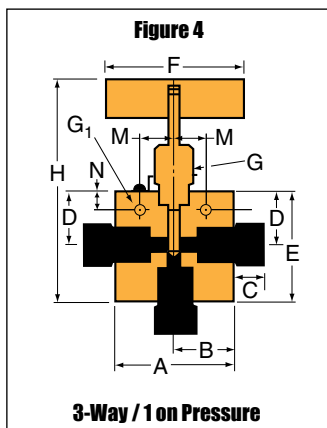

All general terms and conditions of sale, including limitations of our liability, apply to all products and services sold.